

YDS-M7MA-OV5640-1B V2.1 NIR

**5MP OmniVision OV5640-1B MIPI Interface No IR Filter
Auto Focus Camera Module**

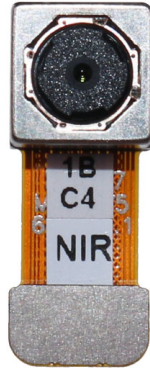

Front View

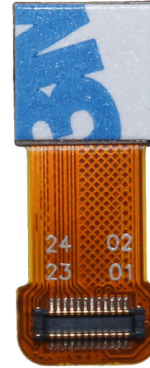

Back View

Specifications

Camera Module No.	YDS-M7MA-OV5640-1B V2.1 NIR
Resolution	5MP
Image Sensor	OV5640-1B
Sensor Type	1/4"
Pixel Size	1.4 um x 1.4 um
EFL	3.20 mm
F.NO	2.80
Pixel	2592 x 1944
View Angle	70.0°(DFOV) 58.6°(HFOV) 45.3°(VFOV)
Lens Dimensions	8.50 x 8.50 x 5.22 mm
Module Size	21.58 x 8.50 mm
Module Type	Auto Focus
Interface	MIPI
Auto Focus VCM Driver IC	Embedded
Lens Model	YDS-LENS-M5182
Lens Type	No IR Filter Lens
Operating Temperature	-30°C to +70°C
Mating Connector	AXT524124



YDS-M7MA-OV5640-1B V2.1 NIR

5MP OmniVision OV5640-1B MIPI Interface No IR Filter
Auto Focus Camera Module



Top View



Side View

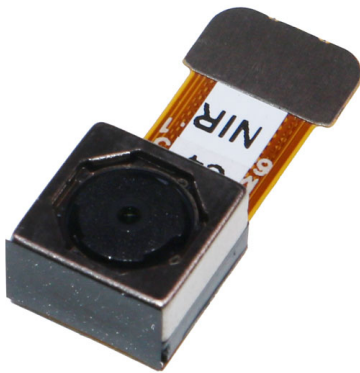

Bottom View

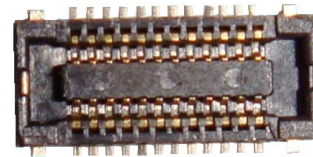

Mating Connector

ROHS

PIN	NAME
1	AFVDD2.8V
2	AVDD2.8V
3	SCL
4	SDA
5	RESET
6	PWDN
7	DOVDD1.8V
8	DVDD1.5V
9	GND
10	XCLK
11	DGND
12	DGND
13	MDN0
14	MCP
15	MDP0
16	MCN
17	DGND
18	DGND
19	DGND
20	MDP1
21	DGND
22	MDN1
23	DGND
24	DGND

Version	Information	Date
V2.1	First Version	4-11-2022

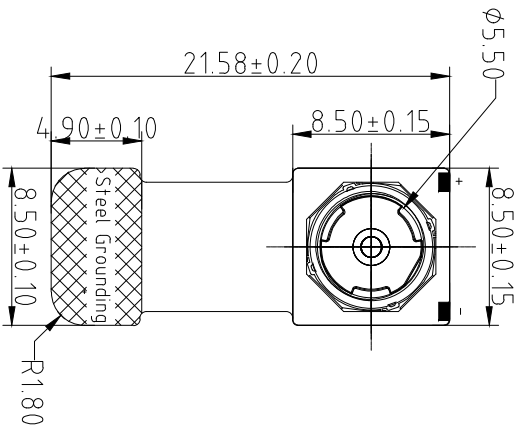
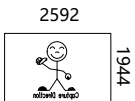

TOP VIEW

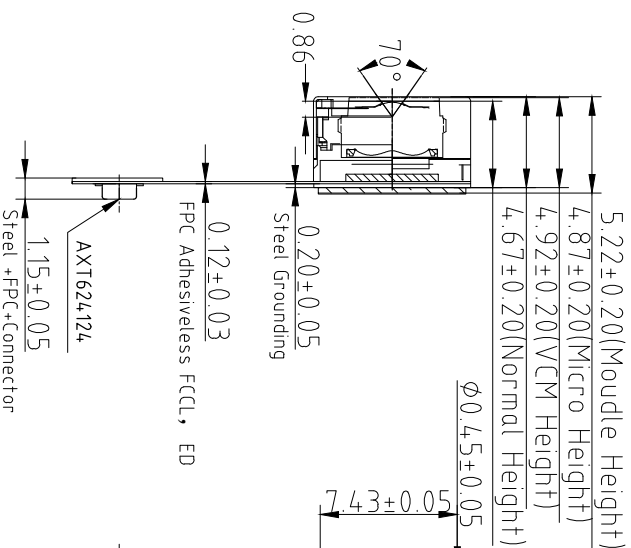

SIDE VIEW

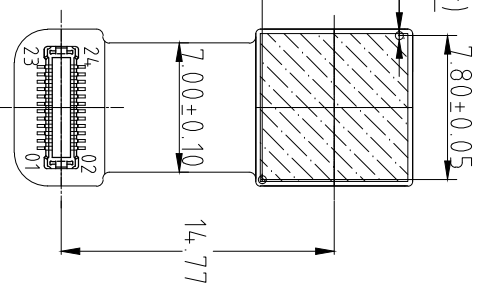

BOTTOM VIEW

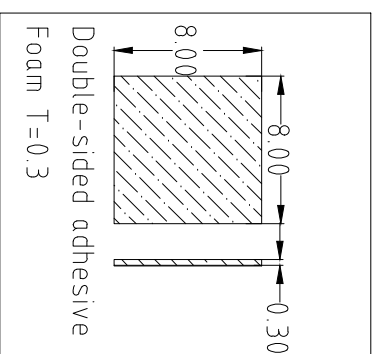

Parameters:

1、Sensor specification:

Image Sensor: OV5640-1B
 Pixel: 1.4um×1.4um
 Lens Type: 1/4
 Important Voltage Description: DVDD1.5V (external power supply);

2、Lens specification:

FOV: 70°(D);58.6°(H);45.3°(V)
 F/NO: 2.8
 TV distortion: <1.0%
 Focal length: 3.2mm
 Composition: 4P

3、Designed By

Kevin

3、Checked By

Aouly

Projection Type:

Model Name:

M7MA-OV5640-1B V2.1 NIR

Unit:

mm

Material:

Scale:

1:1

Sheet:

1 of 1

Version:

1/0

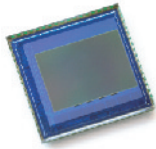

OV5640 5-megapixel product brief



1/4-inch, 5-Megapixel SOC Image Sensor Optimized for High-Volume Mobile Markets



available in
a lead-free
package

The OV5640 delivers a complete 5-megapixel camera solution on a single chip, aimed at offering cost efficiencies that serve the high-volume autofocus (AF) camera phone market. The system-on-a-chip (SOC) sensor features OmniVision's 1.4 micron OmniBSI™ backside illumination architecture to deliver excellent pixel performance and best-in-class low-light sensitivity, while enabling ultra compact camera module designs of 8.5 mm x 8.5 mm with <6 mm z-height. The OV5640 provides the full functionality of a complete camera, including anti-shake technology, AF control, and MIPI while being easier to tune than two-chip solutions, making it an ideal choice in terms of cost, time-to-market and ease of platform integration.

The OV5640 enables 720p HD video at 60 frames per second (fps) and 1080p HD video at 30 fps with complete user control over formatting and output data transfer. The 720p/60 HD video is captured in full field of view (FOV) with 2 x 2 binning, which doubles the sensitivity and improves the signal-to-noise ratio (SNR). Additionally, a unique post-binning re-sampling filter function removes zigzag artifacts around slant edges and minimizes spatial artifacts to deliver even sharper, crisper

color images. To further improve camera performance and user experience, the OV5640 features an internal anti-shake engine for image stabilization, and it supports Scalado™ tagging for faster image preview and zoom.

The OV5640 offers a digital video port (DVP) parallel interface and a high-speed dual lane MIPI interface, supporting multiple output formats. An integrated JPEG compression engine simplifies data transfer for bandwidth-limited interfaces. The sensor's automatic image control functions include automatic exposure control (AEC), automatic white balance (AWB), automatic band filter (ABF), 50/60 Hz automatic luminance detection, and automatic black level calibration (ABLC). The OV5640 delivers programmable controls for frame rate, AEC/AGC 16-zone size/position/weight control, mirror and flip, cropping, windowing, and panning. It also offers color saturation, hue, gamma, sharpness (edge enhancement), lens correction, defective pixel canceling, and noise canceling to improve image quality.

Find out more at www.ovt.com.

applications

- cellular phones
- toys
- PC multimedia
- digital still cameras

ordering information

- **OV05640-A71A-1B** (color, lead-free)
71-pin CSP

features

- 1.4 μm x 1.4 μm pixel with OmniBSI technology for high performance (high sensitivity, low crosstalk, low noise, improved quantum efficiency)
- optical size of 1/4"
- automatic image control functions: automatic exposure control (AEC), automatic white balance (AWB), automatic band filter (ABF), automatic 50/60 Hz luminance detection, and automatic black level calibration (ABLC)
- programmable controls for frame rate, AEC/AGC 16-zone size/position/weight control, mirror and flip, cropping, windowing, and panning
- image quality controls: color saturation, hue, gamma, sharpness (edge enhancement), lens correction, defective pixel canceling, and noise canceling
- support for output formats: RAW RGB, RGB565/555/444, CCIR656, YUV422/420, YCbCr422, and compression
- support for video or snapshot operations
- support for internal and external frame synchronization for frame exposure mode
- support for LED and flash strobe mode
- support for horizontal and vertical sub-sampling, binning
- support for minimizing artifacts on binned image
- support for data compression output
- support for anti-shake
- standard serial SCCB interface
- digital video port (DVP) parallel output interface and dual lane MIPI output interface
- embedded 1.5V regulator for core power
- programmable I/O drive capability, I/O tri-state configurability
- support for black sun cancellation
- support for images sizes: 5 megapixel, and any arbitrary size scaling down from 5 megapixel
- support for auto focus control (AFC) with embedded AF VCM driver
- embedded microcontroller
- suitable for module size of 8.5 x 8.5 x <6mm with both CSP and RW packaging

key specifications (typical)

- **active array size:** 2592 x 1944
- **power supply:**
core: 1.425 ~ 1.675V (with embedded 1.5V regulator)
analog: 2.6 ~ 3.0V (2.8V typical)
I/O: 1.8V / 2.8V
- **power requirements:**
active: 140 mA
standby: 20 μA
- **temperature range:**
operating: -30°C to 70°C junction temperature (see [table 8-2](#))
stable image: 0°C to 50°C junction temperature (see [table 8-2](#))
- **output formats:** 8-/10-bit RGB RAW output
- **lens size:** 1/4"
- **lens chief ray angle:** 24° (see [figure 10-2](#))
- **input clock frequency:** 6~27 MHz
- **max S/N ratio:** 36 dB
- **dynamic range:** 68 dB @ 8x gain
- **maximum image transfer rate:**
QSXGA (2592x1944): 15 fps
1080p: 30 fps
1280x960: 45 fps
720p: 60 fps
VGA (640x480): 90 fps
- **sensitivity:** 600 mV/Lux-sec
- **shutter:** rolling shutter / frame exposure
- **maximum exposure interval:** 1964 x t_{ROW}
- **pixel size:** 1.4 μm x 1.4 μm
- **dark current:** 8 mV/s @ 60°C junction temperature
- **image area:** 3673.6 μm x 2738.4 μm
- **package dimensions:** 5985 μm x 5835 μm

YDS-LENS-M5182

SPECIFICATION	
1. SENSOR SIZE	1/4" (3M COB)
2. MAX IMAGE CIRCLE	$\phi 4.85\text{mm}$
3. TOTAL TRACK	4.0±0.1mm
4. EFL	3.2mm
5. OPTICAL EFL	1.32mm
6. MECHANICAL EFL	0.98mm
7. F/NO	2.8=5f
8. VIEW OR FIELD DIAGONAL	45.3° (Y=1.36) 58.6° (Y=1.81) 70.0° (Y=2.26)
9. OPTICAL DISTORTION	<1.0%
10. TV DISTORTION	<1.0%
11. RELATIVE ILLUMINATION	>42.2%
12. CONSTRUCTION	4P
13. CHIEF RAY ANGLE	<25°
14. CUT FREQUENCY AT 50%	\
15. THREAD	M6.0X0.35P
16. IMAGE QUALITY	AXIS 330lp/mm
	0.7Y 200lp/mm
17. APPEARANCE QUALITY (Scratch/Dirt)	CENTER 20/1C EDGE 40/20

NO	MODIFY CONTENT	NAME	DATE	ANGLE	RANGE	DIM	UNIT	SCALE	REVISION	DATE	REMARK
1	新增规格书(4.3M/2/95.5P (V:0.10))	tonlin	2016-12-05	X.XX	±0.05	mm	mm	10:1	APPROVED	2016-12-05	

NOTE:

- 镜头表面不可有油污、灰尘、毛丝等异物。
- 镜头配VCM锁附高度为 4.2±0.1mm, 扭力为20--120gf.cm。
- 镜头承受推力为≥2.0kg。
- 镜头组品质参数需符合图中要求。

NARROW-PITCH, THIN AND SLIM CONNECTOR FOR BOARD-TO-FPC CONNECTION

NARROW PITCH (0.4 mm) CONNECTORS F4S SERIES

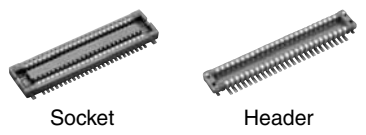

Compliance with RoHS Directive

FEATURES

1. Space-saving (3.6 mm widthwise)
The required space is smaller than our F4 series (40-contact type):

- Socket — 27% smaller,
- Header — 38% smaller

The small size contributes to the miniaturization of target equipment.

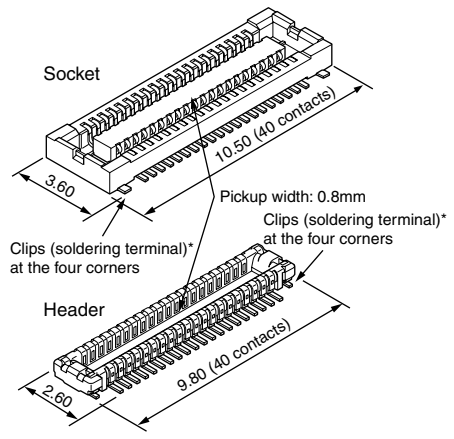

* Clips for preventing the solder joints from being removed

2. Highly reliable
TOUGH CONTACT has strong resistance to adverse environments.
(See Page 6 for details of the structure)
Note: If extra resistance to shock caused by dropping is required, we recommend using our previous F4 Series.

3. The simple lock structure gives tactile feedback that ensures a superior mating/unmating operation feel.

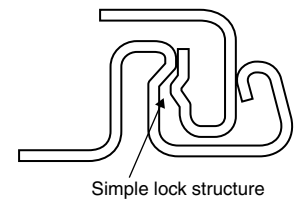

4. Gull-wing type terminals
The gull-wing type terminals facilitate automatic mounting inspections.
5. Connectors for inspection available
Connectors for inspection are available that are ideal for modular unit inspection and inspection in device assembly processes.

APPLICATIONS

Compact portable devices “Cellular phones, DVC, Digital cameras, etc”

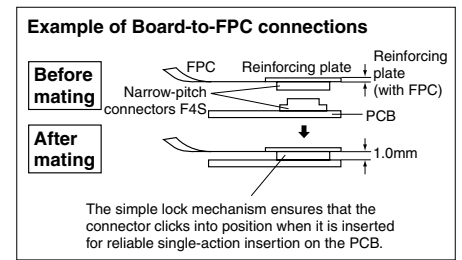

ORDERING INFORMATION

AXT **4**

5: Narrow Pitch Connector F4S (0.4 mm pitch) Socket
6: Narrow Pitch Connector F4S (0.4 mm pitch) Header

Number of contacts (2 digits)

Mated height
<Socket>
1: For mated height 1.0 mm
2: For mated height 1.2 mm
<Header>
1: For mated height 1.0 mm
2: For mated height 1.2 mm

Functions
<Socket, Header>
2: Without positioning bosses

Surface treatment (Contact portion / Terminal portion)
<Socket>
4: Base: Ni plating Surface: Au plating (for Ni barrier available)
<Header>
4: Base: Ni plating Surface: Au plating

Note: Please note that models with a mated height of 1.0 mm (7th digit of part number is “1”) and 1.2 mm (7th digit of part number is “2”) are not compatible.

AXT5, 6

PRODUCT TYPES

Mated height	Number of contacts	Part number		Packing	
		Socket	Header	Inner carton	Outer carton
1.0mm	10	AXT510124	AXT610124	3,000 pieces	6,000 pieces
	12	AXT512124	AXT612124		
	14	AXT514124	AXT614124		
	16	AXT516124	AXT616124		
	18	AXT518124	AXT618124		
	20	AXT520124	AXT620124		
	22	AXT522124	AXT622124		
	24	AXT524124	AXT624124		
	26	AXT526124	AXT626124		
	28	AXT528124	AXT628124		
	30	AXT530124	AXT630124		
	32	AXT532124	AXT632124		
	34	AXT534124	AXT634124		
	36	AXT536124	AXT636124		
	38	AXT538124	AXT638124		
	40	AXT540124	AXT640124		
	42	AXT542124	AXT642124		
	44	AXT544124	AXT644124		
	46	AXT546124	AXT646124		
	48	AXT548124	AXT648124		
50	AXT550124	AXT650124			
54	AXT554124	AXT654124			
60	AXT560124	AXT660124			
64	AXT564124	AXT664124			
70	AXT570124	AXT670124			
80	AXT580124	AXT680124			
1.2mm	10	AXT510224	AXT610224		
	30	AXT530224	AXT630224		
	40	AXT540224	AXT640224		
	50	AXT550224	AXT650224		
	80	AXT580224	AXT680224		

- Notes: 1. Order unit: For mass production: in 1-inner-box (1-reel) units
 Samples for mounting check: in 50-connector units. Please contact our sales office.
 Samples: Small lot orders are possible. Please contact our sales office.
2. The above part numbers are for connectors without positioning bosses, which are standard. When ordering connectors with positioning bosses, please contact our sales office.
3. Please contact us for connectors having a number of contacts other than those listed above.

SPECIFICATIONS

1. Characteristics

	Item	Specifications	Conditions
Electrical characteristics	Rated current	0.3A/contact (Max. 5 A at total contacts)	
	Rated voltage	60V AC/DC	
	Breakdown voltage	150V AC for 1 min.	No short-circuiting or damage at a detection current of 1 mA when the specified voltage is applied for one minute.
	Insulation resistance	Min. 1,000M Ω (initial)	Using 250V DC megger (applied for 1 min.)
	Contact resistance	Max. 90m Ω	Based on the contact resistance measurement method specified by JIS C 5402.
Mechanical characteristics	Composite insertion force	Max. 0.981N/contacts \times contacts (initial)	
	Composite removal force	Min. 0.165N/contacts \times contacts	
Environmental characteristics	Contact holding force (Socket contact)	Min. 0.49N/contacts	Measuring the maximum force. As the contact is axially pull out.
	Ambient temperature	-55°C to +85°C	No freezing at low temperatures. No dew condensation.
	Soldering heat resistance	Peak temperature: 260°C or less (on the surface of the PC board around the connector terminals) 300°C within 5 sec. 350°C within 3 sec.	Infrared reflow soldering Soldering iron
	Storage temperature	-55°C to +85°C (product only) -40°C to +50°C (emboss packing)	No freezing at low temperatures. No dew condensation.
	Thermal shock resistance (header and socket mated)	5 cycles, insulation resistance min. 100M Ω , contact resistance max. 90m Ω	Sequence 1. -55 $\frac{3}{5}$ °C, 30 minutes 2. ~, Max. 5 minutes 3. 85 $\frac{3}{5}$ °C, 30 minutes 4. ~, Max. 5 minutes
	Humidity resistance (header and socket mated)	120 hours, insulation resistance min. 100M Ω , contact resistance max. 90m Ω	Bath temperature 40 \pm 2°C, humidity 90 to 95% R.H.
	Saltwater spray resistance (header and socket mated)	24 hours, insulation resistance min. 100M Ω , contact resistance max. 90m Ω	Bath temperature 35 \pm 2°C, saltwater concentration 5 \pm 1%
	H ₂ S resistance (header and socket mated)	48 hours, contact resistance max. 90m Ω	Bath temperature 40 \pm 2°C, gas concentration 3 \pm 1 ppm, humidity 75 to 80% R.H.
Lifetime characteristics	Insertion and removal life	50 times	Repeated insertion and removal speed of max. 200 times/hours
Unit weight		20-contact type: Socket: 0.03 g Header: 0.01 g	

2. Material and surface treatment

Part name	Material	Surface treatment
Molded portion	LCP resin (UL94V-0)	—
Contact and Post	Copper alloy	Contact portion: Base: Ni plating Surface: Au plating Terminal portion: Base: Ni plating Surface: Au plating (except the terminal tips) The socket terminals close to the portion to be soldered have nickel barriers (exposed nickel portions). Metal clips: Sockets: Base: Ni plating Surface: Pd+Au flash plating (except the terminal tips) Headers: Base: Ni plating Surface: Au plating (except the terminal tips)

AXT5, 6

DIMENSIONS (Unit: mm)

The CAD data of the products with a **CAD Data** mark can be downloaded from: <http://panasonic-electric-works.net/ac>

Socket (Mated height: 1.0 mm and 1.2 mm)

CAD Data

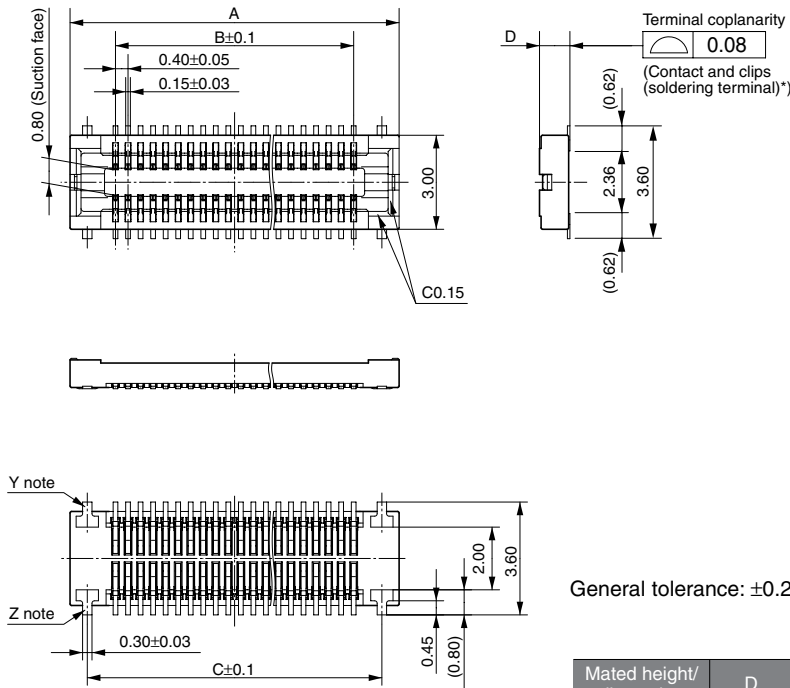
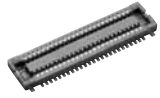

General tolerance: ±0.2

Mated height/ dimension	D
1.0mm	0.97
1.2mm	1.17

Note: Since the clip (soldering terminal)* has a single-piece construction, sections Y and Z are electrically connected.

Dimension table (mm)

Number of contacts/ dimension	A	B	C
10	4.5	1.6	3.4
12	4.9	2.0	3.8
14	5.3	2.4	4.2
16	5.7	2.8	4.6
18	6.1	3.2	5.0
20	6.5	3.6	5.4
22	6.9	4.0	5.8
24	7.3	4.4	6.2
26	7.7	4.8	6.6
28	8.1	5.2	7.0
30	8.5	5.6	7.4
32	8.9	6.0	7.8
34	9.3	6.4	8.2
36	9.7	6.8	8.6
38	10.1	7.2	9.0
40	10.5	7.6	9.4
42	10.9	8.0	9.8
44	11.3	8.4	10.2
46	11.7	8.8	10.6
48	12.1	9.2	11.0
50	12.5	9.6	11.4
54	13.3	10.4	12.2
60	14.5	11.6	13.4
64	15.3	12.4	14.2
70	16.5	13.6	15.4
80	18.5	15.6	17.4

Header (Mated height: 1.0 mm and 1.2 mm)

CAD Data

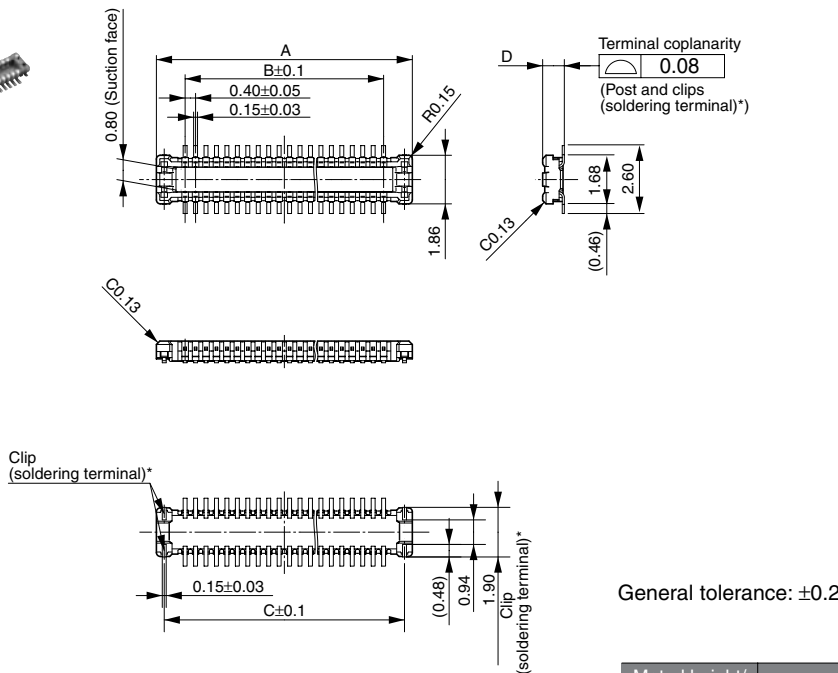

General tolerance: ±0.2

Mated height/ dimension	D
1.0mm	0.83
1.2mm	1.01

Dimension table (mm)

Number of contacts/ dimension	A	B	C
10	3.8	1.6	3.2
12	4.2	2.0	3.6
14	4.6	2.4	4.0
16	5.0	2.8	4.4
18	5.4	3.2	4.8
20	5.8	3.6	5.2
22	6.2	4.0	5.6
24	6.6	4.4	6.0
26	7.0	4.8	6.4
28	7.4	5.2	6.8
30	7.8	5.6	7.2
32	8.2	6.0	7.6
34	8.6	6.4	8.0
36	9.0	6.8	8.4
38	9.4	7.2	8.8
40	9.8	7.6	9.2
42	10.2	8.0	9.6
44	10.6	8.4	10.0
46	11.0	8.8	10.4
48	11.4	9.2	10.8
50	11.8	9.6	11.2
54	12.6	10.4	12.0
60	13.8	11.6	13.2
64	14.6	12.4	14.0
70	15.8	13.6	15.2
80	17.8	15.6	17.2

• Socket and Header are mated

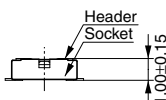

Mated height: 1.0 mm

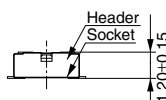

Mated height: 1.2 mm



YDS CAMERA MODULE

your best camera partner

Camera Module Pinout Definition Reference Chart

OmniVision	Sony	Samsung	On-Semi	Aptina	Himax	GalaxyCore	PixArt	SmartSens	Sensors
Pin Signal		Description							
DGND GND		ground for digital circuit							
AGND		ground for analog circuit							
PCLK DCK		DVP PCLK output							
XCLR PWDN XSHUTDOWN STANDBY		power down active high with internal pull-down resistor							
MCLK XVCLK XCLK INCK		system input clock							
RESET RST		reset active low with internal pull-up resistor							
NC NULL		no connect							
SDA SIO_D SIOD		SCCB data							
SCL SIO_C SIOC		SCCB input clock							
VSYNC XVS FSYNC		DVP VSYNC output							
HREF XHS		DVP HREF output							
DOVDD		power for I/O circuit							
AFVDD		power for VCM circuit							
AVDD		power for analog circuit							
DVDD		power for digital circuit							
STROBE FSTROBE		strobe output							
FSIN		synchronize the VSYNC signal from the other sensor							
SID		SCCB last bit ID input							
ILPWM		mechanical shutter output indicator							
FREQ		frame exposure / mechanical shutter							
GPIO		general purpose inputs							
SLASEL		I2C slave address select							
AFEN		CEN chip enable active high on VCM driver IC							
MIPI Interface									
MDN0 DN0 MD0N DATA_N DMO1N		MIPI 1st data lane negative output							
MDP0 DP0 MD0P DATA_P DMO1P		MIPI 1st data lane positive output							
MDN1 DN1 MD1N DATA2_N DMO2N		MIPI 2nd data lane negative output							
MDP1 DP1 MD1P DATA2_P DMO2P		MIPI 2nd data lane positive output							
MDN2 DN2 MD2N DATA3_N DMO3N		MIPI 3rd data lane negative output							
MDP2 DP2 MD2P DATA3_P DMO3P		MIPI 3rd data lane positive output							
MDN3 DN3 MD3N DATA4_N DMO4N		MIPI 4th data lane negative output							
MDP3 DP3 MD3P DATA4_P DMO4P		MIPI 4th data lane positive output							
MCN CLKN CLK_N DCKN		MIPI clock negative output							
MCP CLKP MCP CLK_P DCKN		MIPI clock positive output							
DVP Parallel Interface									
D0 DO0 Y0		DVP data output port 0							
D1 DO1 Y1		DVP data output port 1							
D2 DO2 Y2		DVP data output port 2							
D3 DO3 Y3		DVP data output port 3							
D4 DO4 Y4		DVP data output port 4							
D5 DO5 Y5		DVP data output port 5							
D6 DO6 Y6		DVP data output port 6							
D7 DO7 Y7		DVP data output port 7							
D8 DO8 Y8		DVP data output port 8							
D9 DO9 Y9		DVP data output port 9							
D10 DO10 Y10		DVP data output port 10							
D11 DO11 Y11		DVP data output port 11							

www.YDSCAM.com sales@ydscam.com Phone (WeChat, QQ): (+86) 177 2732 6718

All rights reserved @ YingDeShun Co. Ltd. Specifications subject to change without notice.

Cameras Applications



IMAGING DEVICES



Camera Reliability Test

Reliability Inspection Item		Testing Method	Acceptance Criteria	
Category	Item			
Environmental	Storage Temperature	High 60°C 96 Hours	Temperature Chamber	No Abnormal Situation
		Low -20°C 96 Hours	Temperature Chamber	No Abnormal Situation
	Operation Temperature	High 60°C 24 Hours	Temperature Chamber	No Abnormal Situation
		Low -20°C 24 Hours	Temperature Chamber	No Abnormal Situation
	Humidity	60°C 80% 24 Hours	Temperature Chamber	No Abnormal Situation
	Thermal Shock	High 60°C 0.5 Hours Low -20°C 0.5 Hours Cycling in 24 Hours	Temperature Chamber	No Abnormal Situation
Physical	Drop Test (Free Falling)	Without Package 60cm	10 Times on Wood Floor	Electrically Functional
		With Package 60cm	10 Times on Wood Floor	Electrically Functional
	Vibration Test	50Hz X-Axis 2mm 30min	Vibration Table	Electrically Functional
		50Hz Y-Axis 2mm 30min	Vibration Table	Electrically Functional
		50Hz Z-Axis 2mm 30min	Vibration Table	Electrically Functional
	Cable Tensile Strength Test	Loading Weight 4 kg 60 Seconds Cycling in 24 Hours	Tensile Testing Machine	Electrically Functional
Electrical	ESD Test	Contact Discharge 2 KV	ESD Testing Machine	Electrically Functional
		Air Discharge 4 KV	ESD Testing Machine	Electrically Functional
	Aging Test	On/Off 30 Seconds Cycling in 24 Hours	Power Switch	Electrically Functional
	USB Connector	On/Off 250 Times	Plug and Unplug	Electrically Functional



Camera Inspection Standard

Inspection Item		Inspection Method	Standard of Inspection		
Category	Item				
Appearance	FPC/ PCB	Color	The Naked Eye	Major Difference is Not Allowed.	
		Be Torn/Chopped	The Naked Eye	Copper Crack Exposure is Not Allowed.	
		Marking	The Naked Eye	Clear, Recognizable (Within 30cm Distance)	
	Holder	Scratches	The Naked Eye	The Inside Crack Exposure is Not Allowed	
		Gap	The Naked Eye	Meet the Height Standard	
		Screw	The Naked Eye	Make Sure Screws Are Presented (If Any)	
		Damage	The Naked Eye	The Inside Crack Exposure is Not Allowed	
	Lens	Scratch	The Naked Eye	No Effect On Resolution Standard	
		Contamination	The Naked Eye	No Effect On Resolution Standard	
		Oil Film	The Naked Eye	No Effect On Resolution Standard	
		Cover Tape	The Naked Eye	No Issue On Appearance.	
	Function	Image	No Communication	Test Board	Not Allowed
			Bright Pixel	Black Board	Not Allowed In the Image Center
Dark Pixel			White board	Not Allowed In the Image Center	
Blurry			The Naked Eye	Not Allowed	
No Image			The Naked Eye	Not Allowed	
Vertical Line			The Naked Eye	Not Allowed	
Horizontal Line			The Naked Eye	Not Allowed	
Light Leakage			The Naked Eye	Not Allowed	
Blinking Image			The Naked Eye	Not Allowed	
Bruise			Inspection Jig	Not Allowed	
Resolution			Chart	Follows Outgoing Inspection Chart Standard	
Color			The Naked Eye	No Issue	
Noise			The Naked Eye	Not Allowed	
Corner Dark			The Naked Eye	Less Than 100px By 100px	
Color Resolution			The Naked Eye	No Issue	
Dimension	Height	The Naked Eye	Follows Approval Data Sheet		
	Width	The Naked Eye	Follows Approval Data Sheet		
	Length	The Naked Eye	Follows Approval Data Sheet		
	Overall	The Naked Eye	Follows Approval Data Sheet		

YDSCAM Package Solutions

YDS Camera Module



Complete with Lens Protection Film



Tray with Grid and Space



Place Cameras on the Tray



YDSCAM Package Solutions

Full Tray of Cameras

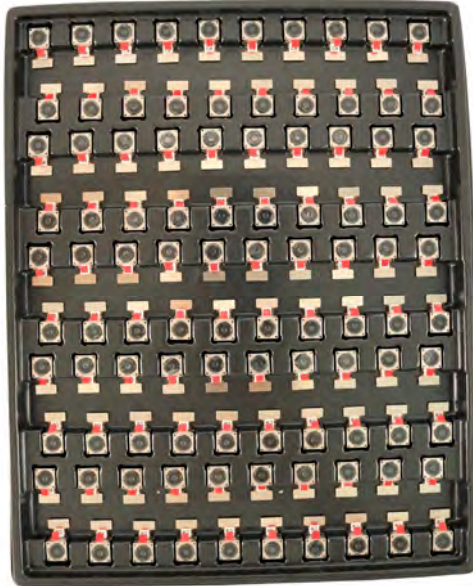

Cover Tray with Lid



Place Tray into Anti-Static Bag



Vacuum the Anti-Static Bag



YDSCAM Package Solutions

Sealed Vacuum Anti-Static Bag with Labels

1. Model and Description 2. Quantity 3. Manufacturing Date Code 4. Caution



YDSCAM Package Solutions

Place Foam Sheets Between Tray Bags



Foam Sheets are Larger Than Trays



Place Foam Sheets and Trays into Box



Foam Sheets are Tightly Fitting in Box



Seal the Carbon Box



Label the Carbon Shipping Box





YDSCAM Package Solutions

USB Camera Module

Complete with Lens Protection Film



Place Camera Sample into Anti-Static Bag

Place USB Cameras into Tray



Seal the Tray with Anti-Static Bag

Label the Carbon Shipping Box



YDSCAM Package Solutions

Place Camera Sample into Anti-Static Bag



Place Connectors into Anti-Static Bag



Label the Sample Bags



Place Connectors into Reel



Place Samples into the Carbon Box



Place Connectors into the Carbon Box





YDS CAMERA MODULE

your best camera partner

Company YDSCAM

YingDeShun Co. Ltd. (YDS) was established in 2017, a next-generation technology driven manufacturer specialized in research, design, and produce of audio and video products. YDS is occupying 20,000 square feet automated plants with 100 employees of annual throughput 30,000,000 units cameras.

YDS provides OEM, ODM design, contract manufacturing, and builds the camera products. You may provide the requirements to us, even with a hand draft, our sales and engineering work together to meet your needs. We consider ourselves your last-term partner in developing practical and innovative solutions.

Our team covers everything from initial concept development to mass produced product. YDS specializes in customized camera design, raw material, electronic engineering, firmware/software development, product testing, and packing design. Our experienced strategic supply systems offer a robust and dependable manufacturing capacity for orders of various sizes.



Limited Warranty

YDS provides the following limited warranty if you purchased the Product(s) directly from YDS company or from YDS's website www.YDSCAM.com. Product(s) purchased from other sellers or sources are not covered by this Limited Warranty. YDS guarantees that the Product(s) will be free from defects in materials and workmanship under normal use for a period of one (1) year from the date you receive the product ("Warranty Period").

For all Product(s) that contain or develop material defects in materials or workmanship during the Warranty Period, YDS will, at its sole option, either: (i) repair the Product(s); (ii) replace the Product(s) with a new or refurbished Product(s) (replacement Product(s) being of identical model or functional equivalent); or (iii) provide you a refund of the price you paid for the Product(s).

This Limited Warranty of YDS is solely limited to repair and/or replacement on the terms set forth above. YDS is not reliable or responsible for any subsequent events.



www.YDSCAM.com sales@ydscam.com Phone (WeChat, QQ): (+86) 177 2732 6718

All rights reserved @ YingDeShun Co. Ltd. Specifications subject to change without notice.



YDS CAMERA MODULE

your best camera partner

YDS Strength

Powerful Factory



Professional Service



Promised Delivery



www.YDSCAM.com sales@ydscam.com Phone (WeChat, QQ): (+86) 177 2732 6718

All rights reserved @ YingDeShun Co. Ltd. Specifications subject to change without notice.